

Outdoor Furniture



Edition I





By

VOOLCAN
Grupo

Nuestra Esencia

Our Essence

ES

En Skyline Design®, la belleza nace entre fibras y manos. Desde 2003, reinventamos la vida al aire libre a través del diseño y la artesanía contemporánea, creando piezas que dialogan con la naturaleza y celebran la calma exterior.

Nuestra filosofía combina tradición manual con innovación tecnológica, ofreciendo mobiliario único donde la textura, la forma y la ligereza conviven con resistencia, sofisticación y comodidad. Más que muebles, creamos espacios: atmósferas que inspiran, abrazan y permanecen.

Con presencia global y una estructura logística estratégica, acompañamos a clientes, arquitectos e interioristas en proyectos residenciales y contract, aportando excelencia, personalización y un servicio impecable.

EN

At Skyline Design®, beauty is born between fibers and hands. Since 2003, we have been reinventing outdoor living through contemporary design and craftsmanship, creating pieces that dialogue with nature and celebrate outdoor tranquility.

Our philosophy combines traditional craftsmanship with technological innovation, offering unique furniture where texture, form, and lightness coexist with strength, sophistication, and comfort. More than furniture, we create spaces: atmospheres that inspire, embrace, and endure.

With a global presence and strategic logistics structure, we accompany clients, architects, and interior designers in residential and contract projects, providing excellence, customization, and impeccable service.



Artesanía para el exterior Craftsmanship for the Outdoors

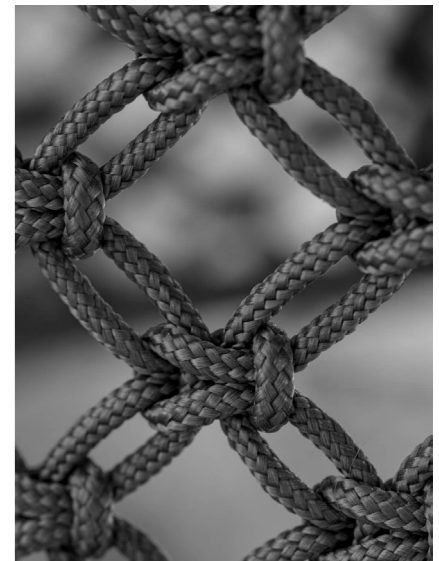
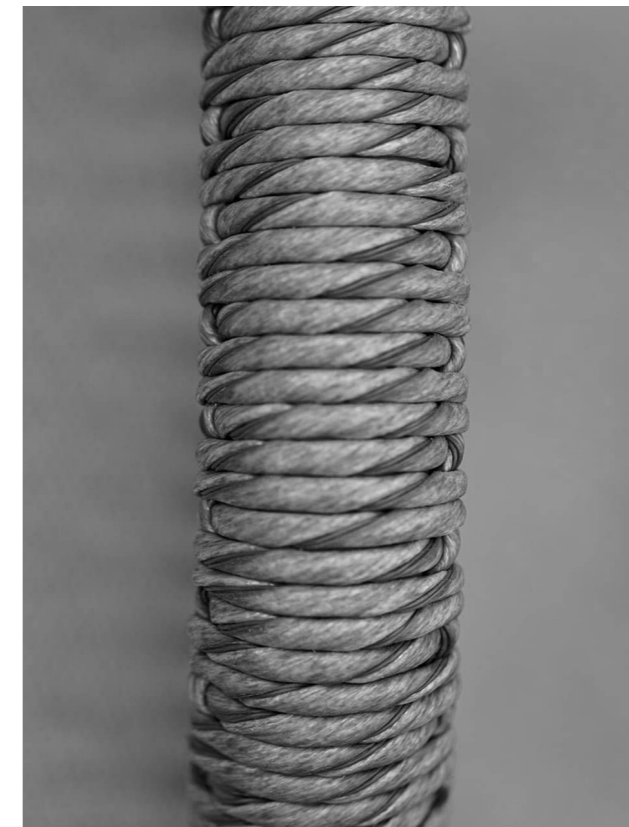

El Arte del Trenzado / The Art of Braiding



ES

El trenzado es el lenguaje que define a Skyline Design®. Un proceso artesanal que requiere precisión, paciencia y sensibilidad un oficio heredado que convierte cada pieza en una obra única.

Nuestras fibras cobran vida en manos expertas que tejen, tensan y forman patrones orgánicos y geométricos, creando superficies que respiran y envuelven. Cada trenza refleja equilibrio y técnica; cada nudo, la dedicación y talento de nuestros artesanos.

EN

Weaving is the language that defines Skyline Design®. A manual craft that demands precision, patience and intuition an ancestral skill that transforms each piece into a sculptural expression.

Our fibers come to life in the hands of master artisans who weave, tighten and form organic and geometric patterns, creating surfaces that breathe and envelop. Every braid reflects balance and technique; every knot, expertise and passion.

Precisión técnica, esencia artesanal



Technical Precision, Crafted Essence

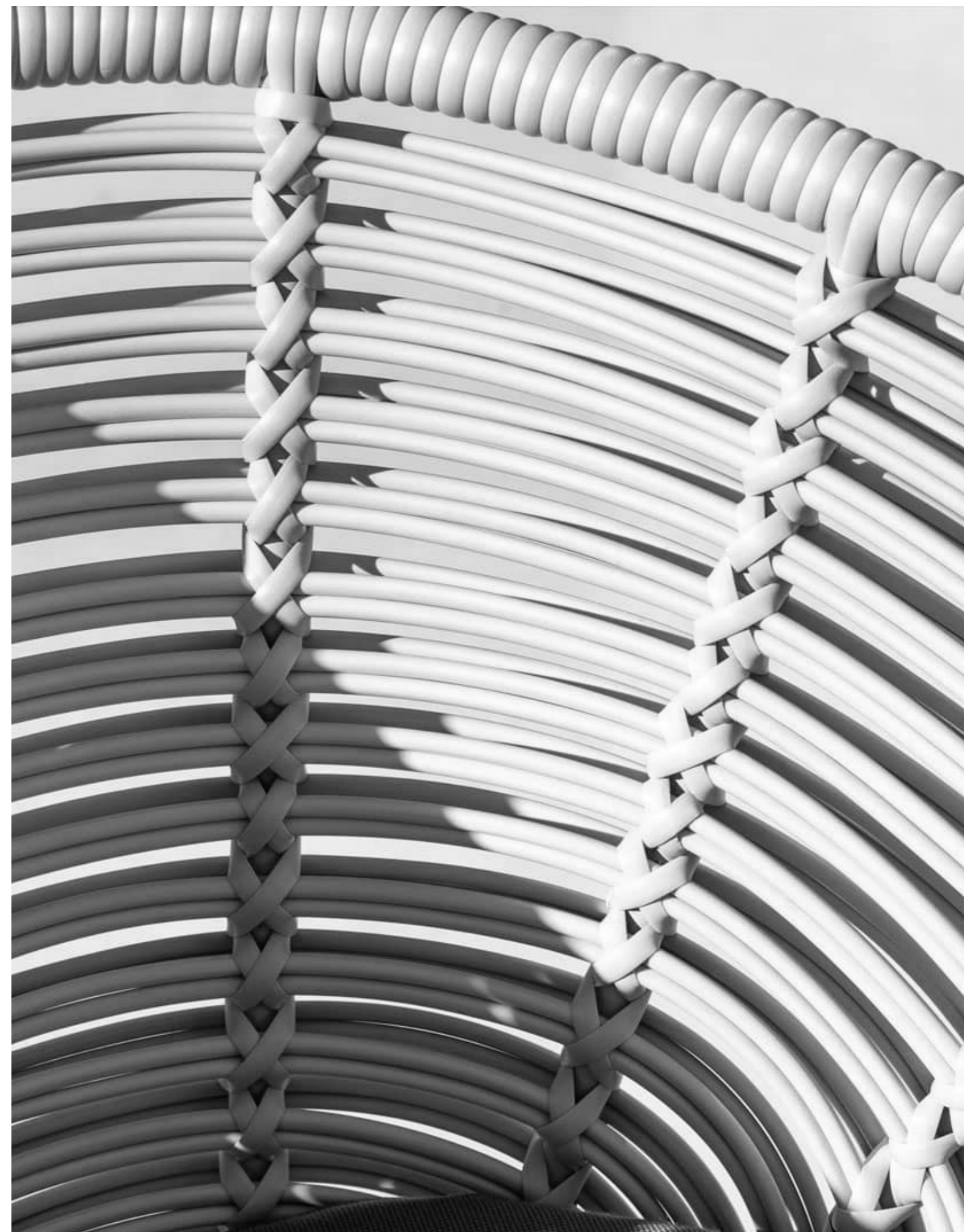

Innovación & Calidad Material

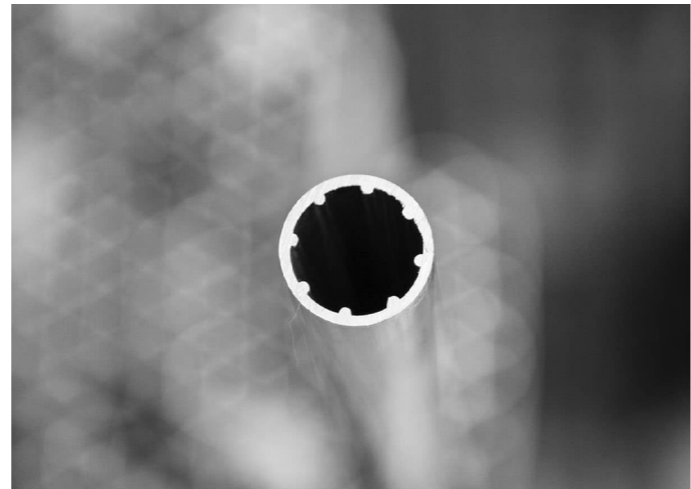

Innovation & Material Quality

ES La calidad comienza en la materia y se perfecciona en el detalle. Cada componente ha sido seleccionado por su rendimiento, belleza y sostenibilidad, sometido a pruebas exhaustivas y optimizado para resistir el paso del tiempo.

Aluminio / Aluminum



Madera Teak / Teak wood



Fibra Poliéster / Polyester Fiber

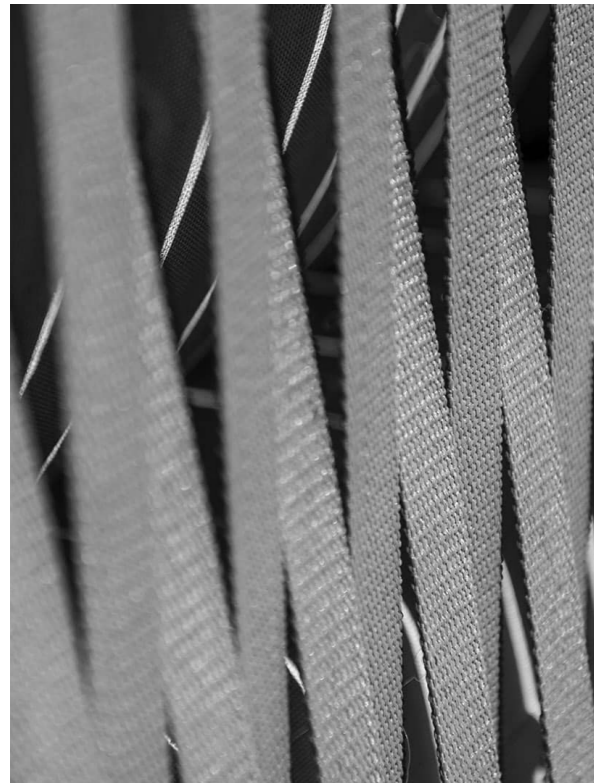

Fibra de HDPE / HDPE Fiber

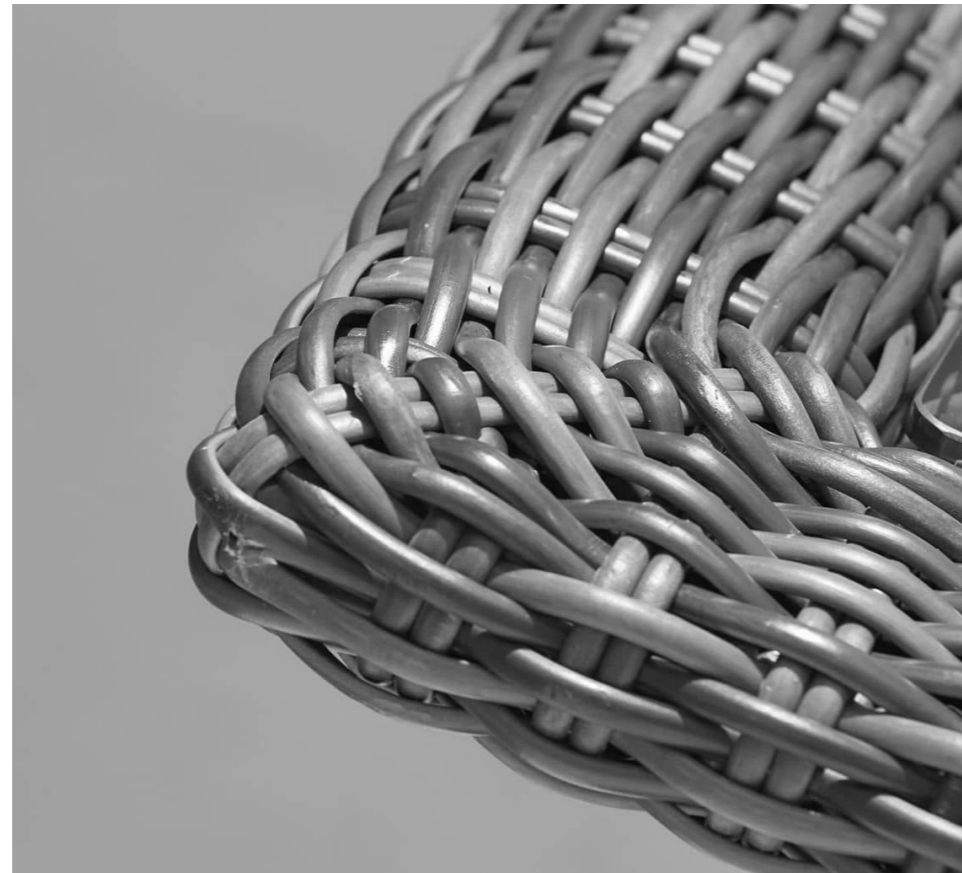

EN Quality begins with the materials and is perfected in the details. Each component has been selected for its performance, beauty, and sustainability, subjected to exhaustive testing, and optimized to withstand the passage of time.

Vidrio Templado / Tempered Glass wood



Porcelánico / Porcelain tile



EN Through careful workmanship and fine materials, we blend tradition and innovation to design pieces that coexist with the outdoors while maintaining their beauty.

Tejido acrílico / Acrylic fabric



Tejido de Poliéster / Polyester fabric



ES A través de un trabajo cuidadoso y materiales nobles, fusionamos tradición e innovación para diseñar piezas que conviven con el exterior manteniendo su belleza.

Nara ²⁰ Clover ³⁴ Botit ⁴⁸ Neo Alaska ⁶²

Neo Krabi ⁷² Neo Moma ⁸⁴ Neo Dynasty ⁹⁴

Boston ¹⁰⁴ Rodona ¹¹⁶

Oram ¹³⁰ Neo Cube ¹³⁴ Faber ¹³⁸ Shade ¹⁴⁴

Nara collection by Mudat Studio

Nara fusiona artesanía y precisión industrial, donde las líneas de su estructura armonizan con el trenzado manual de las cuerdas. Nara merges craftsmanship and industrial precision, where the lines of its structure harmonize with the manual braiding of the ropes.





23122 Nara Sofa 2st. Brown 23121 Nara Armchair Brown
23123 Nara Low Center Table Brown 23125 Nara Aux. Table Brown

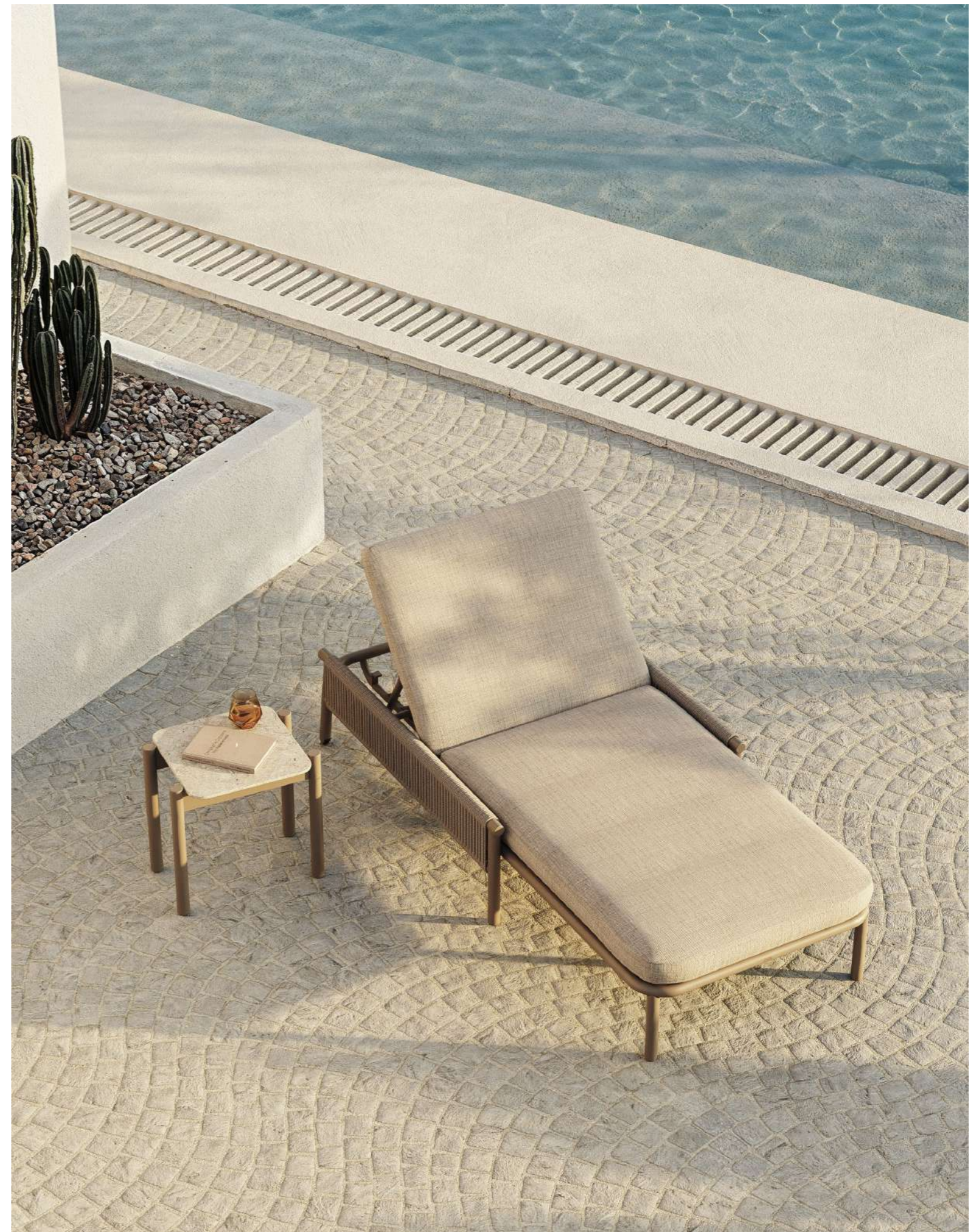

23128 Nara Lounger Brown
23125 Nara Aux. Table Brown





23120.01 Nara Dining Armchair Green
23127.01 Nara Dining Table Green



23122 Nara Sofa 2st. Brown
23121 Nara Armchair Brown

23123 Nara Low Center Table Brown
23124 Nara High Center Table Brown
23125 Nara Aux. Table Brown



23129 Nara Stool Brown
23126 Nara Bar Table Brown

Clover collection *by Junpei & Iori Tamaki*

Una colección de mobiliario de exterior definida por siluetas que evocan formas de trébol. Su diseño único a la vez que sencillo aporta individualidad y armonía a un espacio.

An outdoor furniture collection defined by silhouettes that evoke clover shapes. Its unique yet simple design brings both individuality and harmony to a space.





23133 Clover Sofa 3st. White
23134 Clover Low Center Table White

23139 SQ Center Table White
23135 Clover Aux. Table White

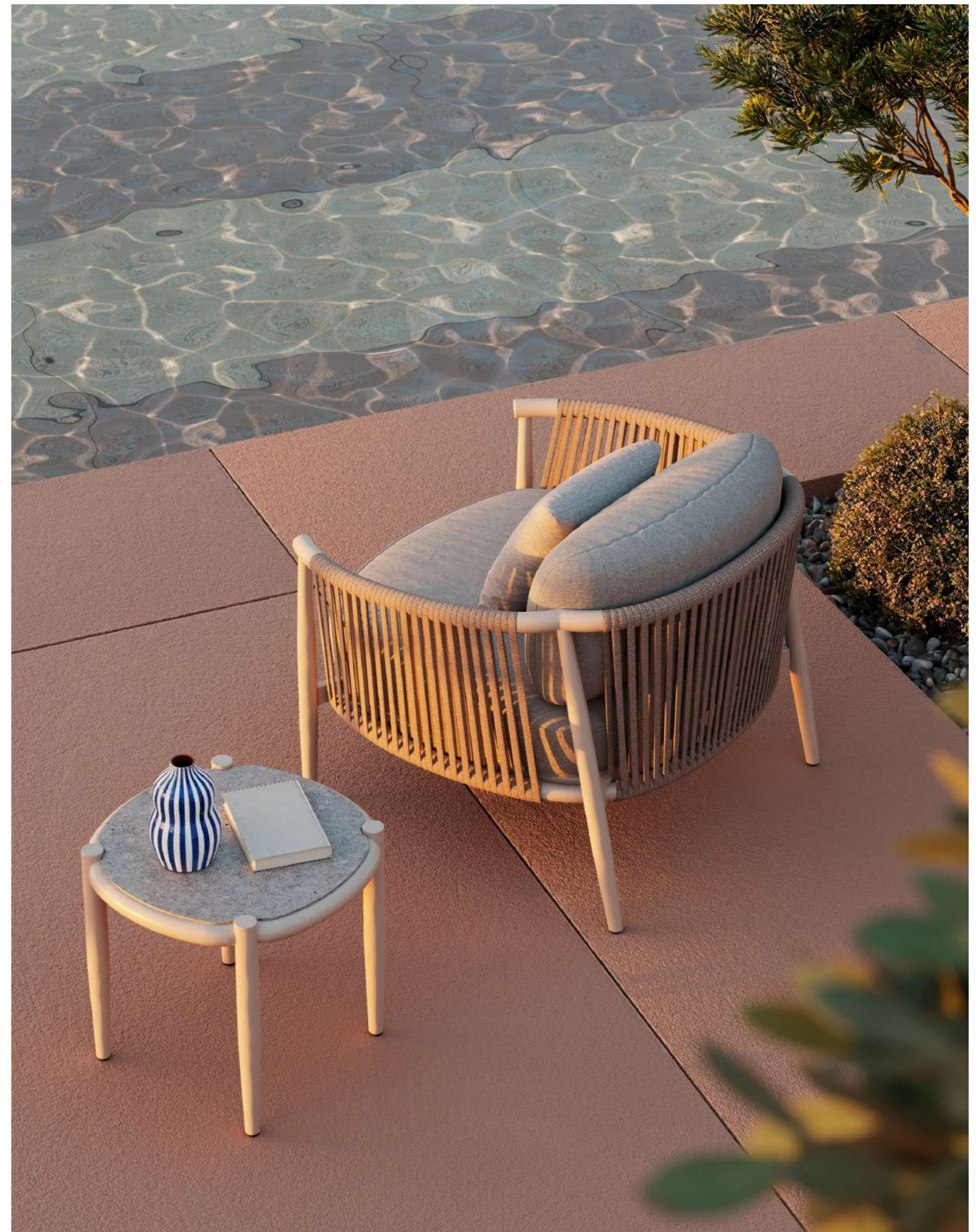

23131.01 Clover Armchair Black
23131 Clover Armchair White

23135 Clover Aux. Table White



23136.01 Clover Daybed Black
23138.01 Clover High Center Table Black



03 Rodona chair
04 Rodona dining table

23137 Clover Dining Table White
23130 Clover Dining Armchair White



23130 Clover Dining Armchair White



23136 Clover Daybed White
23138 Clover High Center Table White

Botit collection *by Santiago Sevillano*

Esta colección exterior encapsula artesanía en estructuras ligeras de líneas redondeadas. Piezas sofisticadas y agradables que respiran espíritu mediterráneo.

This outdoor collection encapsulates craftsmanship within light structures with rounded lines. Sophisticated and pleasant pieces that breathe a Mediterranean spirit.





23261 Botit Armchair
23265 Botit Aux. Table







23260 Botit Dining armchair
23267 Botit Dining Table



23260 Botit Dining armchair
23267 Botit Dining Table





23260 Botit Sofa 2st.

23264 Botit Rect. Center Table

23265 Botit Aux. Table

Neo Alaska collection *by Noel Royo Asenjo*

Caracterizada por un diseño de fibras entrelazadas que rinde homenaje a la cestería tradicional. La fusión de sus formas curvas y su paleta mineral aporta una identidad visual única y una elegancia serena al espacio.

Characterized by an interwoven fiber design that pays homage to traditional basketry. The fusion of its curved shapes and mineral palette brings a unique visual identity and serene elegance to the space.







20110 Neo Alaska Dining Armchair
20165 Marroi Rect. Dining table





20116 Neo Alaska Daybed
20167.00.01 Marroi Round Center Table

20111 Neo Alaska Armchair
20113 Neo Alaska Sofa 3St



Neo Krabi collection *by Noel Royo Asenjo*

Una evolución de nuestro icónico diseño, que combina la calidez de los materiales nobles con una silueta inspirada en la botánica mediterránea, logrando una ligereza visual que permite que el paisaje sea el verdadero protagonista.

An evolution of our iconic design, combining the warmth of fine materials with a silhouette inspired by Mediterranean botany, achieving a visual lightness that allows the landscape to take center stage.







20151 Neo Krabi Armchair
20153 Neo Krabi Sofa 3St

20161 Neo Krabi Hanging Armchair
20155 Neo Krabi Aux. Table



20155 Neo Krabi Aux. Table
20156 Neo Krabi Daybed



20150 Neo Krabi Dining Armchair
20160 Neo Krabi Rect. Dining Table



20150 Neo Krabi Dining Armchair
20160 Neo Krabi Rect. Dining Table

20155 Neo Krabi Aux. Table
20156 Neo Krabi Daybed

Neo Moma collection *by Noel Royo Asenjo*

Su patrón de fibras entrelazadas y su nueva gama de colores hacen renacer la colección para convertirla en la pieza central de un exterior. Un diseño que equilibra resistencia y elegancia para realzar la belleza del entorno.

Its interwoven fiber pattern and new color range breathe new life into the collection, making it the centerpiece of any outdoor space. A design that balances strength and elegance to enhance the beauty of the surroundings.







20130 Neo Moma Dining Armchair
20140 Neo Moma Dining Table



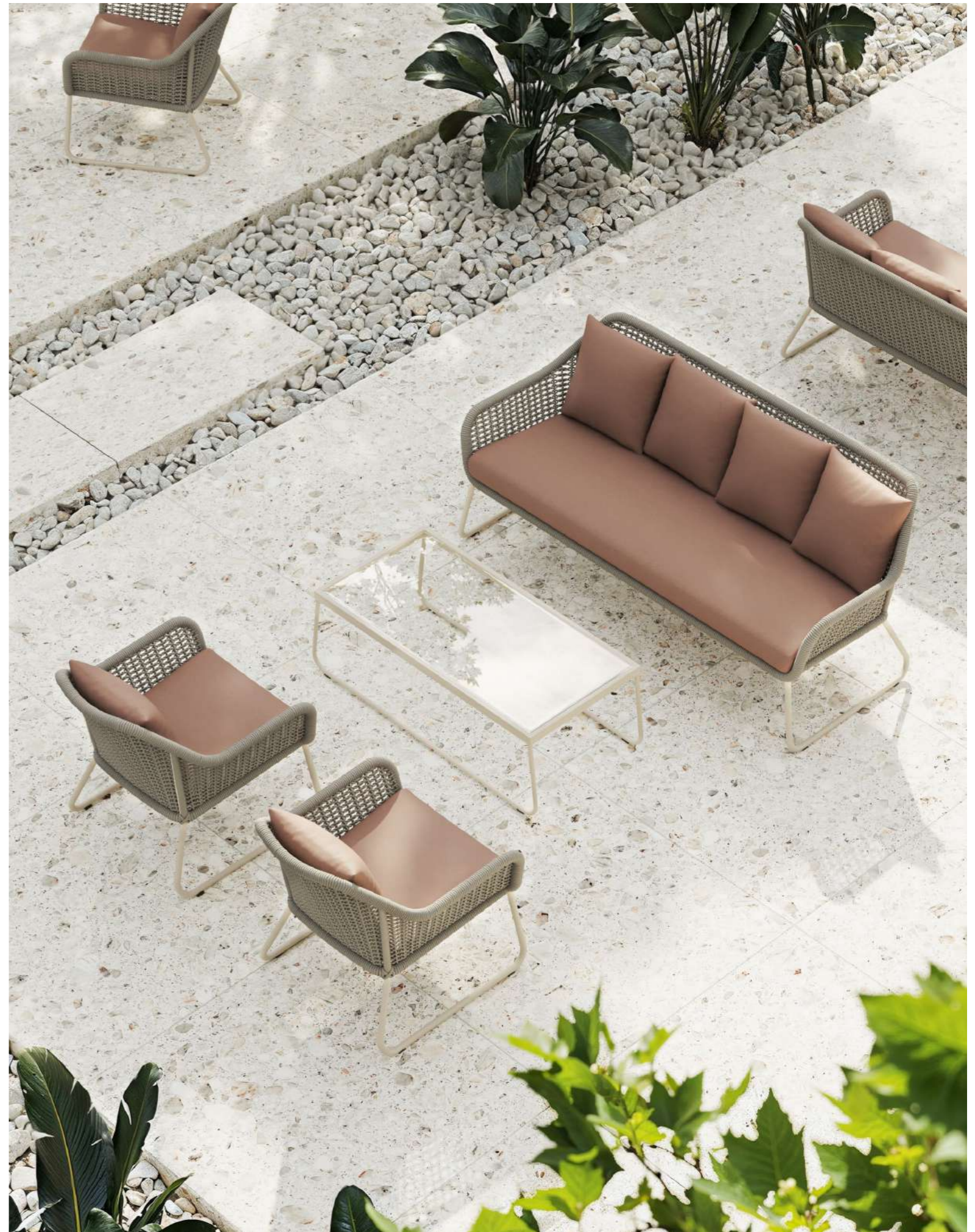

20144 Neo Moma Daybed
20131 Neo Moma Armchair

20133 Neo Moma Sofa St
20134 Neo Moma Rect. Coffee Table

Neo Dynasty collection *by Noel Royo Asenjo*

Una colección con alma propia, donde su icónico patrón de fibras se viste de tonos chocolate para crear un juego magnético de sombras y texturas. Elegancia serena que invita a disfrutar de un lujo sin artificios.

A collection with a soul of its own, where its iconic fiber pattern is dressed in chocolate tones to create a magnetic interplay of shadows and textures. Serene elegance that invites you to enjoy luxury without artifice.





20121 Neo Dynasty Armchair
20123 Neo Dynasty Sofa 3St
20124 Neo Dynasty SQ Coffee Table
20127 Neo Dynasty Aux. Table



20120 Neo Dynasty Dining Armchair
20165 Marroi Rect. Dining Table





Boston collection *by Santiago Sevillano*



Define la elegancia contemporánea a través de su distintivo juego de líneas y respaldos envolventes que crean un espacio íntimo. Un diseño icónico que eleva el nivel de un espacio para convertirlo en un escenario de auténtico lujo.

It defines contemporary elegance through its distinctive interplay of lines and enveloping backrests that create an intimate space. An iconic design that elevates a space to transform it into a setting of authentic luxury.



24151 Boston Armchair
24153 Boston Sofa 3St

24152 Boston Sofa 2St
24154 Boston SQ Coffee Table



24157 Boston Dining Armchair
24159.01 Boston Rect. Dining Table



24161 Boston Stool
24157 Boston Dining Armchair





24166 Boston Daybed
24155 Boston Side Table

Rodona collection

by Santiago Sevillano

Define un nuevo estándar de sofisticación gracias a sus formas cóncavas y acogedoras. Una apuesta por los detalles y la continuidad visual que convierte cada pieza en un ícono de serenidad que transforma el exterior.

It sets a new standard of sophistication thanks to its concave, welcoming shapes. A commitment to detail and visual continuity that turns each piece into an icon of serenity that transforms the exterior.





24171 Rodona Armchair
24174 Rodona Round Coffee Table



24177 Rodona Dining Armchair
24178.01 Rodona Dining Table



24171 Rodona Dining Armchair
24179 Rodona Stool

24180.02 Rodona SQ Bar Table
24180.03 Rodona Rect. Bar table







24185 Rodona Low Daybed



Oram collection *by Belén Burguete*

De un estilo minimalista y moderno el daybed Oram está inspirado en las tiendas de campaña. Basado en el concepto de espacio de relax o desconexión.

With a minimalist and modern style, the Oram daybed is inspired by camping tents. It's based on the concept of a space for relaxation or disconnection.





Neo Cube collection *by Noel Royo Asenjo*

Transforma el descanso en una experiencia arquitectónica. Sus grandes óculos laterales crean un diálogo constante con el entorno, ofreciendo un santuario privado de confort y distinción.

Transform relaxation into an architectural experience. Its large side windows create a constant dialogue with the surroundings, offering a private sanctuary of comfort and distinction.





20163 Neo Cube Daybed

Faber collection *by Santiago Sevillano*

Faber es un tributo a la elegancia orgánica y la maestría artesanal. Con una forma inspirada en la sofisticación de los legendarios huevos de Fabergé, este daybed ofrece un refugio ovoide envolvente de texturas naturales y diseño icónico.

Faber is a tribute to organic elegance and master craftsmanship. With a shape inspired by the sophistication of the legendary Fabergé eggs, this daybed offers an enveloping ovoid refuge of natural textures and iconic design.







23504 Daybed Faber Kubu Betta

Shade collection *by Noel Royo Asenjo*

Destaca por un imponente trenzado artesanal de diseño envolvente, disponible en dos exclusivos acabados. Una pieza que aporta carácter y personalidad inconfundible a cualquier zona de descanso.

It stands out for its impressive handcrafted braiding with an enveloping design, available in two exclusive finishes. A piece that brings character and unmistakable personality to any relaxation area.



02973.01 Daybed Shade





Designers



Junpei & Iori Tamaki



Mudat Studio



Noel Royo Asenjo



Santiago Sevillano



Belén Burguete

Materials and Finishes

Technical specifications

Nara collection *by Mudat Studio*

1. Aluminium cocoa ral 7006 + grau beige
6mm polyrope

2. Aluminium cement grey ral 7033 + grau
beige 6mm polyrope



3. Fabrics

4. Ceramics Top



Ref: 23121 **Sillon Nara Marron | Armchair Brown**





 23.55 kg
 0.6 m3
 96X89X73 cm

Alto asiento | *High seat* 45 cm
 Alto brazo | *High arm* 61 cm

Ref: 23121.01 **Sillon Nara Verde | Armchair Green**





 23.55 kg
 0.6 m3
 96X89X73 cm

Alto asiento | *High seat* 45 cm
 Alto brazo | *High arm* 61 cm

Ref: 23122 **Sofa 2pl. Nara Marron | Sofa 2st. Brown**





 38.60 kg
 1.08 m3
 167X89X73 cm

Alto asiento | *High seat* 45 cm
 Alto brazo | *High arm* 61 cm

Ref: 23122.01 **Sofa 2pl. Nara Verde | Sofa 2st. Green**





 38.60 kg
 1.08 m3
 167X89X73 cm

Alto asiento | *High seat* 45 cm
 Alto brazo | *High arm* 61 cm

Ref: 23119 **Sofa 3pl. Nara Marron | Sofa 3st. Brown**





 56 kg
 1.43 m3
 220X89X73 cm

Alto asiento | *High seat* 45 cm
 Alto brazo | *High arm* 61 cm

Ref: 23119.01 **Sofa 3pl. Nara Verde | Sofa 3st. Green**





 56 kg
 1.43 m3
 220X89X73 cm

Alto asiento | *High seat* 45 cm
 Alto brazo | *High arm* 61 cm

Ref: 23123 **Centro Nara Bajo Marron | Low Center Table Brown**





 20.25 kg
 0.31 m3
 120x69x37 cm

tope porcelánico | *porcelanic top* 120x60 cm
 grueso tapa | *thick top* 8 mm

Ref: 23123.01 **Centro Nara Bajo Verde | Low Center Table Green**





 20.25 kg
 0.31 m3
 120x69x37 cm

tope porcelánico | *porcelanic top* 120x60 cm
 grueso tapa | *thick top* 8 mm

Ref: 23124 **Centro Nara Alto Marron | High Center Table Brown**



 17.40 kg
 0.29 m3
 74X83X47 cm

tope porcelánico | *porcelanic top* 74X74 cm
 grueso tapa | *thick top* 8 mm

Ref: 23124.01 **Centro Nara Alto Verde | High Center Table Green**

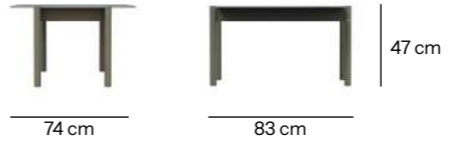

 17.40 kg
 0.29 m3
 74X83X47 cm

tope porcelánico | *porcelanic top* 74X74 cm
 grueso tapa | *thick top* 8 mm

El volumen especificado se refiere al producto en su estado completamente montado. El peso indicado incluye la estructura del producto junto con los cojines y/o topes correspondientes.

The stated volume refers to the fully assembled product. The indicated weight includes the product structure together with the cushions and/or stoppers.

El volumen especificado se refiere al producto en su estado completamente montado. El peso indicado incluye la estructura del producto junto con los cojines y/o topes correspondientes.

The stated volume refers to the fully assembled product. The indicated weight includes the product structure together with the cushions and/or stoppers.

Ref: 23125 **Mesa Aux. Nara Marron | Aux. Table Brown**

40 cm 49 cm 47 cm

7.45 kg
 0.18 m³
 40X49X47 cm

tope porcelánico | *porcelanic top* 40X40 cm
 grueso tapa | *thick top* 8 mm

Ref: 23125.01 **Mesa Aux. Nara Verde | Aux. Table Green**

40 cm 49 cm 47 cm

7.45 kg
 0.185 m³
 40x49x47 cm

tope porcelánico | *porcelanic top* 40X40 cm
 grueso tapa | *thick top* 8 mm

Ref: 23120 **Sillon Com. Nara Marron | Dining Armchair Brown**

65 cm 60 cm 80 cm

12 kg
 0.31 m³
 65X60X80 cm

Alto asiento | *High seat* 46 cm
 Alto brazo | *High arm* 66.5 cm

Ref: 23120.01 **Sillon Com. Nara Verde | Dining Armchair Green**

65 cm 60 cm 80 cm

12 kg
 0.31 m³
 65X60X80 cm

Alto asiento | *High seat* 46 cm
 Alto brazo | *High arm* 66.5 cm

Ref: 23129 **Taburete Nara Marron | Stool Brown**

61 cm 59 cm 104 cm

12 kg
 0.38 m³
 61X59X104 cm

Alto asiento | *High seat* 70 cm
 Alto brazo | *High arm* 90.50 cm

Ref: 23129.01 **Taburete Nara Verde | Stool Green**

61 cm 59 cm 104 cm

12 kg
 0.38 m³
 61X59X104 cm

Alto asiento | *High seat* 70 cm
 Alto brazo | *High arm* 90.50 cm

Ref: 23127 **Mesa Com. Nara Marron | Dining Table Brown**

210 cm 110 cm 76.4 cm

74 kg
 2.02 m³
 240x110x76.4cm

tope porcelánico | *porcelanic top* 240x110 cm
 grueso tapa | *thick top* 8 mm

Ref: 23127.01 **Mesa Com. Nara Verde | Dining Table Green**

210 cm 110 cm 76.4 cm

74 kg
 2.02 m³
 240x110x76.4 cm

tope porcelánico | *porcelanic top* 240x110 cm
 grueso tapa | *thick top* 8 mm

Ref: 23126 **Mesa Bar Nara Marron | Bar Table Brown**

90 cm 90 cm 105 cm

27.10 kg
 0.85 m³
 90X90X105 cm

tope porcelánico | *porcelanic top* 90x90 cm
 grueso tapa | *thick top* 8 mm

Ref: 23126.01 **Mesa Bar Nara Verde | Bar Table Green**

90 cm 90 cm 105 cm

27.10 kg
 0.85 m³
 90X90X105 cm

tope porcelánico | *porcelanic top* 90X90 cm
 grueso tapa | *thick top* 8 mm

El volumen especificado se refiere al producto en su estado completamente montado. El peso indicado incluye la estructura del producto junto con los cojines y/o topes correspondientes.

The stated volume refers to the fully assembled product. The indicated weight includes the product structure together with the cushions and/or stoppers.

El volumen especificado se refiere al producto en su estado completamente montado. El peso indicado incluye la estructura del producto junto con los cojines y/o topes correspondientes.

The stated volume refers to the fully assembled product. The indicated weight includes the product structure together with the cushions and/or stoppers.

Ref: 23128

Tumbona Nara Marron | *Lounger Brown*



94 cm



204 cm

38 cm



34.56 kg



0.73 m3



204X94X38 cm

Alto asiento | *High seat* 36 cm

Alto brazo | *High arm* 40 cm

Ref: 23128.01

Tumbona Nara Verde | *Lounger Green*



94 cm



204 cm

38 cm



34.56 kg



0.73 m3



204X94X38 cm

Alto asiento | *High seat* 36 cm

Alto brazo | *High arm* 40 cm

El volumen especificado se refiere al producto en su estado completamente montado. El peso indicado incluye la estructura del producto junto con los cojines y/o topes correspondientes.

The stated volume refers to the fully assembled product. The indicated weight includes the product structure together with the cushions and/or stoppers.

Clover collection *by Junpei & Iori Tamaki*

- 1. Aluminium carbon
- 2. Black frd 16.5mm
- 3. Aluminium white wash

- 4. Rau beige atmosphere frd 16.5mm
- 5. Fabrics
- 6. Ceramic tops



Ref: 23131 **Sillon Clover Blanco | Armchair White**





 20.35 kg
 0.54 m3
 94x84x68 cm

Alto asiento | *High seat* 45 cm
 Alto brazo | *High arm* 61 cm

Ref: 23131.01 **Sillon Clover Negro | Armchair Black**





 20.35 kg
 0.54 m3
 94x84x68 cm

Alto asiento | *High seat* 45 cm
 Alto brazo | *High arm* 61 cm

Ref: 23132 **Sofa 2pl. Clover Blanco | Sofa 2st. White**





 31.40 kg
 0.95 m3
 165x84x68 cm

Alto asiento | *High seat* 45 cm
 Alto brazo | *High arm* 61 cm

Ref: 23132.01 **Sofa 2pl. Clover Negro | Sofa 2st. Black**



 31.40 kg
 0.95 m3
 165x84x68 cm

Alto asiento | *High seat* 45 cm
 Alto brazo | *High arm* 61 cm

Ref: 23133 **Sofa 3pl. Clover Blanco | Sofa 3st. White**



 52.75 kg
 1,35 m3
 237x84x68 cm

Alto asiento | *High seat* 45 cm
 Alto brazo | *High arm* 61 cm

Ref: 23133.01 **Sofa 3pl. Clover Negro | Sofa 3st. Black**





 52.75 kg
 1,35 m3
 237x84x68 cm

Alto asiento | *High seat* 45 cm
 Alto brazo | *High arm* 61 cm

Ref: 23134 **Centro Bajo Clover Blanco | Low Center Table White**





 18.05 kg
 0.19 m3
 120x60x26 cm

tope porcelánico | *porcelanic top* 116x56 cm
 grueso tapa | *thick top* 8 mm

Ref: 23134.01 **Centro Bajo Clover Black | Low Center Table Black**





 18.05 kg
 0.19 m3
 120x60x26 cm

tope porcelánico | *porcelanic top* 116x56 cm
 grueso tapa | *thick top* 8 mm

Ref: 23138 **Centro Alto Clover Blanco | High Center Table White**





 12.95 kg
 0.17 m3
 84x60x34 cm

tope porcelánico | *porcelanic top* 80x56 cm
 grueso tapa | *thick top* 8 mm

Ref: 23138.01 **Centro Alto Nara Negro | High Center Table Black**



 12.95 kg
 0.17 m3
 84x60x34 cm

tope porcelánico | *porcelanic top* 80x56 cm
 grueso tapa | *thick top* 8 mm

El volumen especificado se refiere al producto en su estado completamente montado. El peso indicado incluye la estructura del producto junto con los cojines y/o topes correspondientes.



The stated volume refers to the fully assembled product. The indicated weight includes the product structure together with the cushions and/or stoppers.

El volumen especificado se refiere al producto en su estado completamente montado. El peso indicado incluye la estructura del producto junto con los cojines y/o topes correspondientes.

The stated volume refers to the fully assembled product. The indicated weight includes the product structure together with the cushions and/or stoppers.

Ref: 23139 Centro Cuad. Clover Blanco | *SQ Center Table White*





 20.40 kg
 0.27 m3
 90x90x34 cm

tope porcelánico | *porcelanic top* 86x86 cm
 grueso tapa | *thick top* 8 mm

Ref: 23139.01 Centro Cuad. Clover Negro | *SQ Center Table Black*





 20.40 kg
 0.27 m3
 90x90x34 cm

tope porcelánico | *porcelanic top* 86x86 cm
 grueso tapa | *thick top* 8 mm

Ref: 23130 Sillon Com. Clover Blanco | *Dining Armchair White*



 8.60 kg
 0.24 m3
 61x57x70,4 cm

Alto asiento | *High seat* 45 cm
 Alto brazo | *High arm* 67 cm

Ref: 23130.01 Sillon Com. Clover Negro | *Dining Armchair Black*





 8.60 kg
 0.24 m3
 61x57x70,4 cm

Alto asiento | *High seat* 45 cm
 Alto brazo | *High arm* 67 cm

Ref: 23137 Mesa Com. Clover Blanco | *Dining Table White*





 68.35 kg
 1.8 m3
 240x100x75 cm

tope porcelánico | *porcelanic top* 236.2x96.2 cm
 grueso tapa | *thick top* 8 mm

Ref: 23137.01 Mesa Com. Clover Negro | *Dining Table Black*



 68.35 kg
 1.8 m3
 240x100x75 cm

tope porcelánico | *porcelanic top* 236.2x96.2 cm
 grueso tapa | *thick top* 8 mm

Ref: 23136 Daybed Clover Blanco | *Daybed White*



 44.25 kg
 1.46 m3
 165x132,5x67cm

Alto asiento | *High seat* 43 cm
 Alto brazo | *High arm* 57 cm

Ref: 23136.01 Daybed Clover Negro | *Daybed Black*





 44.25 kg
 1.46 m3
 165x132,5x67cm

Alto asiento | *High seat* 43 cm
 Alto brazo | *High arm* 57 cm

Ref: 23135 Mesa Aux. Clover Blanco | *Aux. Table White*





 7.70 kg
 0.11 m3
 50x50x45 cm

tope porcelánico | *porcelanic top* 46x46 cm
 grueso tapa | *thick top* 8 mm

Ref: 23135.01 Mesa Aux. Clover Negro | *Aux. Table Black*



 7.70 kg
 0.11 m3
 50x50x45 cm

tope porcelánico | *porcelanic top* 46x46 cm
 grueso tapa | *thick top* 8 mm

El volumen especificado se refiere al producto en su estado completamente montado. El peso indicado incluye la estructura del producto junto con los cojines y/o topes correspondientes.

The stated volume refers to the fully assembled product. The indicated weight includes the product structure together with the cushions and/or stoppers.

El volumen especificado se refiere al producto en su estado completamente montado. El peso indicado incluye la estructura del producto junto con los cojines y/o topes correspondientes.

The stated volume refers to the fully assembled product. The indicated weight includes the product structure together with the cushions and/or stoppers.

Botit collection *by Santiago Sevillano*

1. Aluminium white wash

2. Palm spring webbing 35x2mm & polyrope 8mm

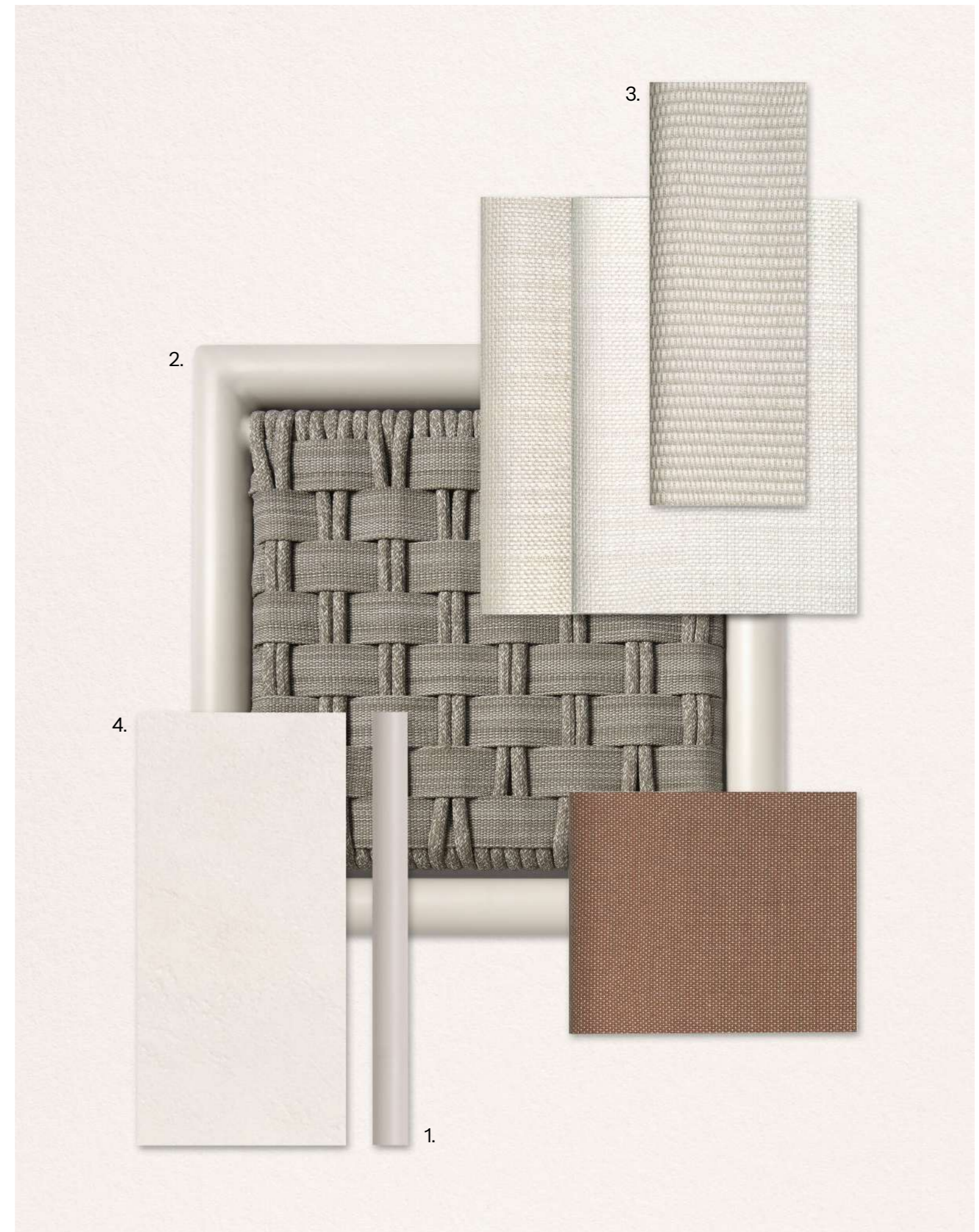

4. Fabrics

5. Ceramic tops



Ref: 23261 **Sillon Botit | Armchair**



 29.91 kg
 0.54 m3
 94x95x61 cm

Alto asiento | *High seat* 42 cm
 Alto brazo | *High arm* 61 cm

Ref: 23262 **Sofa 2pl. Botit | Sofa 2st.**



 45.80 kg
 1.07 m3
 184x95x61 cm

Alto asiento | *High seat* 42 cm
 Alto brazo | *High arm* 61 cm

Ref: 23263 **Sofa 3pl. Botit | Sofa 3st.**





 66.40 kg
 1.58 m3
 272x95x61 cm

Alto asiento | *High seat* 42 cm
 Alto brazo | *High arm* 61 cm

Ref: 23264 **Centro Rect. Botit | Rect. Center Table**





 17.60 kg
 0.25 m3
 120X60X34 cm

tope porcelánico | *porcelanic top* 114.7X48.3cm
 grueso tapa | *thick top* 8 mm

Ref: 23264.01 **Centro Cuad. Botit | SQ. Center Table**



 25.20 kg
 0.34 m3
 100X100X34 cm



tope porcelánico | *porcelanic top* 94.7x84.3 cm
 grueso tapa | *thick top* 8 mm

El volumen especificado se refiere al producto en su estado completamente montado. El peso indicado incluye la estructura del producto junto con los cojines y/o topes correspondientes.

The stated volume refers to the fully assembled product. The indicated weight includes the product structure together with the cushions and/or stoppers.

Ref: 23260 **Sillon Com. Botit | Dining Armchair**





 12.90 kg
 0.28 m3
 65X58X74 cm

Alto asiento | *High seat* 61 cm
 Alto brazo | *High arm* 74 cm

Ref: 23269 **Taburete Botit | Stool**





 12.26 kg
 0.30 m3
 56X60X97 cm

Alto asiento | *High seat* 84 cm
 Alto brazo | *High arm* 97 cm

Ref: 23267 **Mesa Com. Botit | Dining Table**



 76.20 kg
 1.82 m3
 240x100x76 cm

tope porcelánico | *porcelanic top* 231.7x86.7 cm
 grueso tapa | *thick top* 8 mm

Ref: 23268 **Tumbona Botit | Lounger**





 35.72 kg
 1.01 m3
 99x167x61 cm

Alto asiento | *High seat* 42 cm
 Alto brazo | *High arm* 61 cm

Ref: 23266 **Daybed Botit | Daybed**



 59.45 kg
 1.72 m3
 185x152x61 cm

Alto asiento | *High seat* 42 cm
 Alto brazo | *High arm* 61 cm



El volumen especificado se refiere al producto en su estado completamente montado. El peso indicado incluye la estructura del producto junto con los cojines y/o topes correspondientes.

The stated volume refers to the fully assembled product. The indicated weight includes the product structure together with the cushions and/or stoppers.

Ref: 23265

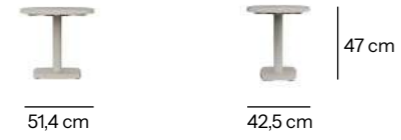
Mesa Aux. Botit | *Aux. Table*



 9.10 kg
 0.1 m3
 51,4X42,5X47 cm

tope porcelánico | *porcelanic top* 47.1x38.2 cm
 grueso tapa | *thick top* 8 mm

El volumen especificado se refiere al producto en su estado completamente montado. El peso indicado incluye la estructura del producto junto con los cojines y/o topes correspondientes.

The stated volume refers to the fully assembled product. The indicated weight includes the product structure together with the cushions and/or stoppers.

Neo Alaska collection *by Noel Royo Asenjo*



1. Black forest polyrod 6mm

3. Fabrics

2. Weathered teak

Ref: 20111

Sillon Neo Alaska | *Armchair*



16.19 kg
 0.33 m3
 88x86x81.5 cm

Alto asiento | *High seat* 45 cm

Ref: 20113

Sofa 3pl. Neo Alaska | *Sofa 3St.*



34.60 kg
 0.82 m3
 198x86x82 cm

Alto asiento | *High seat* 45 cm

Ref: 20114

Mesa Centro Neo Alaska | *Center Table*



15.45 kg
 0.29 m3
 120x60x40 cm

tope de teca | *teak top* 120x60 cm
 grueso tapa | *thick top* 3 cm

Ref: 20115

Mesa Aux. Neo Alaska | *Aux. Table*



14.5 kg
 0.14m3
 50x50x55 cm

tope de teca | *teak top* 46x46 cm
 grueso tapa | *thick top* 3 cm

Ref: 20110

Sillon Com. Neo Alaska | *Dining Armchair*



8.89 kg
 0.17 m3
 63x65x80 cm

tope porcelánico | *porcelanic top* 48 cm

Ref: 20164

Mesa Com. Cuadrada Marroi | *Square Dining Table*



31.12 kg
 0.75 m3
 100x100x75 cm

tope de teca | *teak top* 100x100 cm
 grueso tapa | *thick top* 4 cm

Ref: 20165

Mesa Com. Rectangular Marroi | *Rect. Dining Table*



36.56 kg
 1,8 m3
 240x100x76 cm

tope de teca | *teak top* 240x100 cm
 grueso tapa | *thick top* 4 cm

Ref: 20119

Taburete Neo Alaska | *Bar Stool*



12.44 kg
 0.48 m3
 63x63x110 cm

Alto asiento | *High seat* 78 cm

Ref: 20166

Mesa Bar Marroi | *Bar Table*



35.10 kg
 0.68 m3
 80x80x107 cm

tope de teca | *teak top* 80x80 cm
 grueso tapa | *thick top* 4 cm

Ref: 20116

Daybed Neo Alaska | *Daybed*



48.13 kg
 1.05 m3
 160x160x80 cm

Alto asiento | *High seat* 46 cm

El volumen especificado se refiere al producto en su estado completamente montado. El peso indicado incluye la estructura del producto junto con los cojines y/o topes correspondientes.

The stated volume refers to the fully assembled product. The indicated weight includes the product structure together with the cushions and/or stoppers.

El volumen especificado se refiere al producto en su estado completamente montado. El peso indicado incluye la estructura del producto junto con los cojines y/o topes correspondientes.

The stated volume refers to the fully assembled product. The indicated weight includes the product structure together with the cushions and/or stoppers.

Ref: 20167

Centro Marroi Cuadrada | *SQ Center Table*



8.7 kg
 0.14 m3
 50x50x48 cm

tope de teca | *teak top* 50x50 cm
 grueso tapa | *thick top* 3 cm

Ref: 20167.00.01

Centro Marroi Redonda | *Round Center Table*



8.7 kg
 0.14 m3
 Ø50x48 cm

tope de teca | *teak top* Ø50 cm
 grueso tapa | *thick top* 3 cm

El volumen especificado se refiere al producto en su estado completamente montado. El peso indicado incluye la estructura del producto junto con los cojines y/o topes correspondientes.

The stated volume refers to the fully assembled product. The indicated weight includes the product structure together with the cushions and/or stoppers.

Neo Krabi collection *by Noel Royo Asenjo*



1. Charcoal rope 5mm rm 2501-56

3. Fabrics

2. Weathered teak

Ref: 20151 **Sillon Neo Krabi | *Armchair***

92 cm 80 cm 76 cm

Alto asiento | *High seat* 41 cm

15.18 kg
 0.46 m3
 92x80x76 cm

Ref: 20152 **Sofa 2pl. Neo Krabi | *Sofa 2St.***

147 cm 80 cm 76 cm

Alto asiento | *High seat* 41 cm

25.83 kg
 0.67 m3
 147x80x76 cm

Ref: 20153 **Sofa 3pl. Neo Krabi | *Sofa 3St.***

206 cm 80 cm 76 cm

Alto asiento | *High seat* 41 cm

34.06 kg
 0.89 m3
 206x80x76 cm

Ref: 20154 **Mesa Centro Neo Krabi | *Center Table***

120 cm 60 cm 40 cm

tope de teca | *teak top* 120x60 cm
grueso tapa | *thick top* 3 cm

15.45 kg
 0.29 m3
 120x60x40 cm

Ref: 20155 **Mesa Aux. Neo Krabi | *Aux. Table***

50 cm 50 cm 55 cm

tope de teca | *teak top* 50x50 cm
grueso tapa | *thick top* 3 cm

8.7 kg
 0.14 m3
 50x50x55 cm

Ref: 20150 **Sillon Com. Neo Krabi | *Dining Armchair***

65 cm 56 cm 80 cm

Alto asiento | *High seat* 48 cm

9.10 kg
 0.28 m3
 65x56x80 cm

Ref: 20157 **Mesa Com. Cuadrada Neo Krabi | *Square Dining Table***

100 cm 100 cm 75 cm

tope teca | *teak top* 100x100 cm
grueso tapa | *thick top* 3 cm

25.2 kg
 0.50 m3
 100x100x75 cm

Ref: 20160 **Mesa Com. Rectangular Neo Krabi | *Rect. Dining Table***

200 cm 100 cm 75 cm

tope teca | *teak top* 200x100 cm
grueso tapa | *thick top* 3 cm

51.7 kg
 0.95 m3
 200x100x75 cm

Ref: 20159 **Taburete Neo Krabi | *Bar Stool***

65 cm 57 cm 109 cm

Alto asiento | *High seat* 77 cm

15.23 kg
 0.46 m3
 65x57x109 cm

Ref: 20162 **Sillon Aux. Neo Krabi | *Aux. Armchair***

108 cm 86 cm 97 cm

Alto asiento | *High seat* 42 cm
Alto brazo | *High arm* 66 cm

17.45 kg
 0.90 m3
 108x86x97 cm

El volumen especificado se refiere al producto en su estado completamente montado. El peso indicado incluye la estructura del producto junto con los cojines y/o topes correspondientes.

The stated volume refers to the fully assembled product. The indicated weight includes the product structure together with the cushions and/or stoppers.

El volumen especificado se refiere al producto en su estado completamente montado. El peso indicado incluye la estructura del producto junto con los cojines y/o topes correspondientes.

The stated volume refers to the fully assembled product. The indicated weight includes the product structure together with the cushions and/or stoppers.

Ref: 20158

Tumbona Neo Krabi | *Lounger*



61.3 cm



200 cm

30 cm



12.8 kg



0.37 m3



61.3x200x30 cm

Alto asiento | *High seat* 36 cm

Ref: 20156

Daybed Neo Krabi | *Daybed*



160 cm



160 cm

76 cm



41.63 kg



1.94 m3



160x160x76 cm

Alto asiento | *High seat* 42 cm

Ref: 20161

Columpio Neo Krabi | *Hanging Armchair with stand*



102 cm



138 cm

196 cm



43.83 kg



1.5 m3



102x138x196 cm

Alto asiento | *High seat* 42-52 cm

El volumen especificado se refiere al producto en su estado completamente montado. El peso indicado incluye la estructura del producto junto con los cojines y/o topes correspondientes.

The stated volume refers to the fully assembled product. The indicated weight includes the product structure together with the cushions and/or stoppers.

Neo Moma collection *by Noel Royo Asenjo*

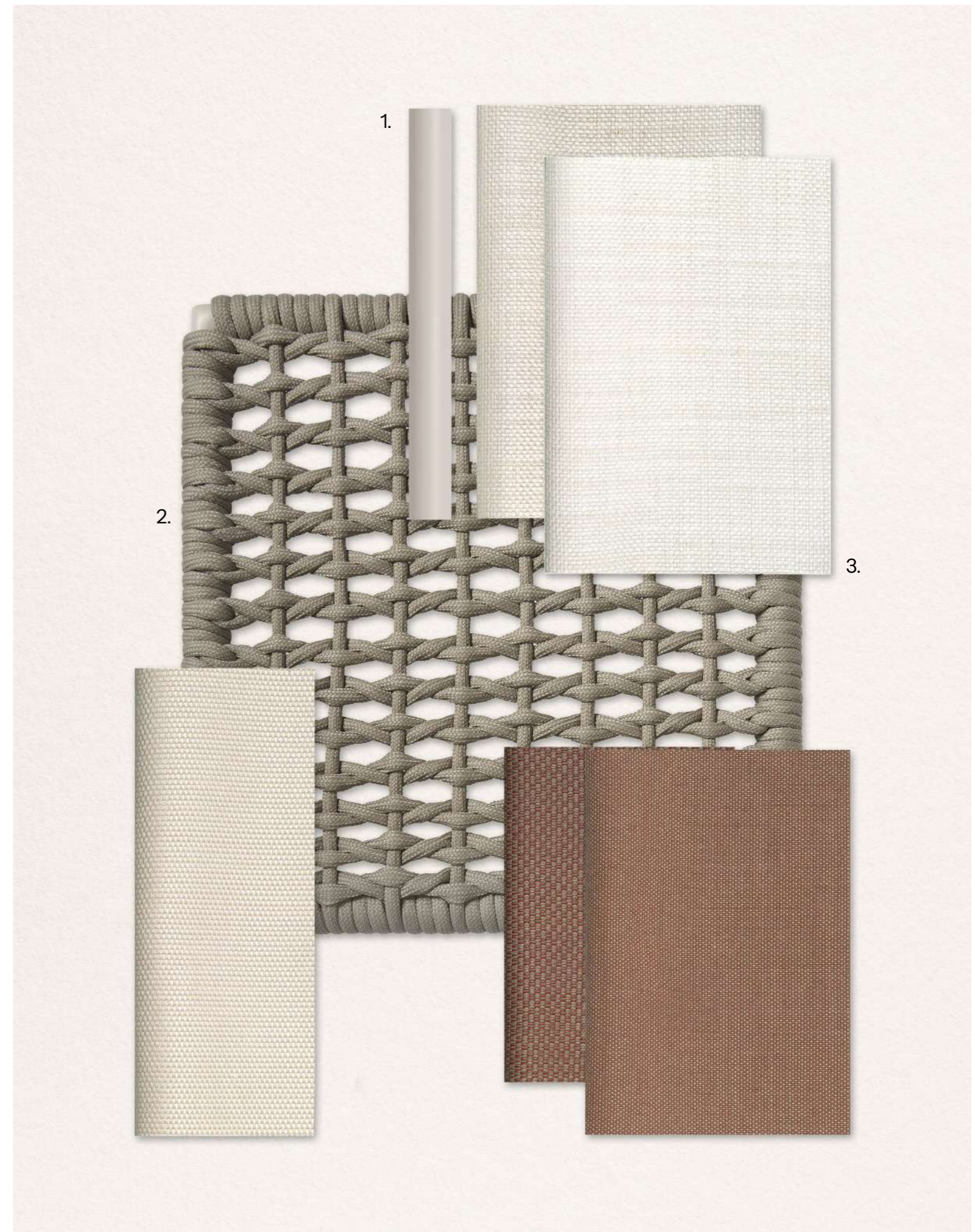

1. Aluminum white wash

2. Polyrope 8mm beige

3. Fabrics

Ref: 20131 **Sillon Neo Moma | Armchair**

73 cm 85 cm 86 cm

10.05 kg
 0.53 m³
 73x85x86 cm

Alto asiento | *High seat* 48 cm
 Alto brazo | *High arm* 65 cm

Ref: 20133 **Sofa Neo Moma | Sofa**

193 cm 85 cm 86 cm

24 kg
 0.97 m³
 193x85x86

Alto asiento | *High seat* 48 cm
 Alto brazo | *High arm* 65 cm

Ref: 20134 **Mesa Centro Neo Alaska | Center Table**

127 cm 60 cm 42 cm

17.65 kg
 0.4 m³
 127x60x42 cm

tope cristal | *glass top* 115.7x55.7 cm
 grueso tapa | *thick top* 6 mm

Ref: 20135 **Mesa Rincón Neo Moma | Side Table**

57 cm 50 cm 51 cm

4.28 kg
 0.2 m³
 57x50x51 cm

tope cristal | *glass top* 45.7x45.7 cm
 grueso tapa | *thick top* 6 mm

Ref: 20138 **Tumbona Neo Moma | Lounger**

68 cm 200 cm 30 cm

19.71 kg
 0.50 m³
 68x200x30 cm

Alto asiento | *High seat* 36 cm

El volumen especificado se refiere al producto en su estado completamente montado. El peso indicado incluye la estructura del producto junto con los cojines y/o topes correspondientes.

The stated volume refers to the fully assembled product. The indicated weight includes the product structure together with the cushions and/or stoppers.

Ref: 20130 **Sillon Com. Neo Moma | Dining Armchair**

66 cm 69 cm 91 cm

6.93 kg
 0.41 m³
 66x69x91 cm

Alto asiento | *High seat* 48 cm
 Alto brazo | *High arm* 66 cm

Ref: 20140 **Mesa Com. Neo Moma | Dining Table**

220 cm 100 cm 76 cm

60.67 kg
 0.57 m³
 220x100x75 cm

tope cristal | *glass top* 215.7x95.5 cm
 grueso tapa | *thick top* 6 mm

Ref: 20137 **Mesa Com. Cuadrada Neo Moma | SQ Dining Table**

100 cm 100 cm 76 cm

32.40 kg
 0.33 m³
 100x100x76 cm

tope cristal | *glass top* 95.7x95.7 cm
 grueso tapa | *thick top* 6 mm

Ref: 20136 **Daybed Neo Moma | Daybed**

200 cm 200 cm 200 cm

129.45 kg
 2.56 m³
 200x200x200 cm

Alto asiento | *High seat* 51 cm

Ref: 20144 **Daybed Red. Neo Moma | Round Daybed**

Ø200 cm 77 cm

51.80 kg
 3.12 m³
 Ø200x77 cm

Alto asiento | *High seat* 48 cm



El volumen especificado se refiere al producto en su estado completamente montado. El peso indicado incluye la estructura del producto junto con los cojines y/o topes correspondientes.

The stated volume refers to the fully assembled product. The indicated weight includes the product structure together with the cushions and/or stoppers.

Ref: 20139

Columpio Neo Moma con stand | *Hanging Chair with stand*





 53.31 kg
 2.10 m3
 102x138x196 cm

Alto asiento | *High seat* 45-52 cm

Ref: 20141

Cabaña Neo Moma comedor | *Cabana Swing Dining Moma*







 248.92 kg
 2.56 m3
 313x185x260cm

Tope madera de teca | *teak top* 185x100 cm
 grueso tapa | *thick top* 4 cm
 alto asiento / *high seat* 55 cm

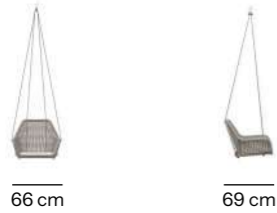
Ref: 20143

Silla Columpio Neo Moma | *Hanging Chair*





 6.43 kg
 0.17 m3
 66x69 cm

Alto asiento | *High seat* 55 cm
 Alto brazo | *High arm* 73 cm

Ref: 20142

Lampara Neo Moma | *Lamp*



 4.50 kg
 0.27 m3
 80x80x40 cm

El volumen especificado se refiere al producto en su estado completamente montado. El peso indicado incluye la estructura del producto junto con los cojines y/o topes correspondientes.

The stated volume refers to the fully assembled product. The indicated weight includes the product structure together with the cushions and/or stoppers.

Neo Dynasty collection *by Noel Royo Asenjo*

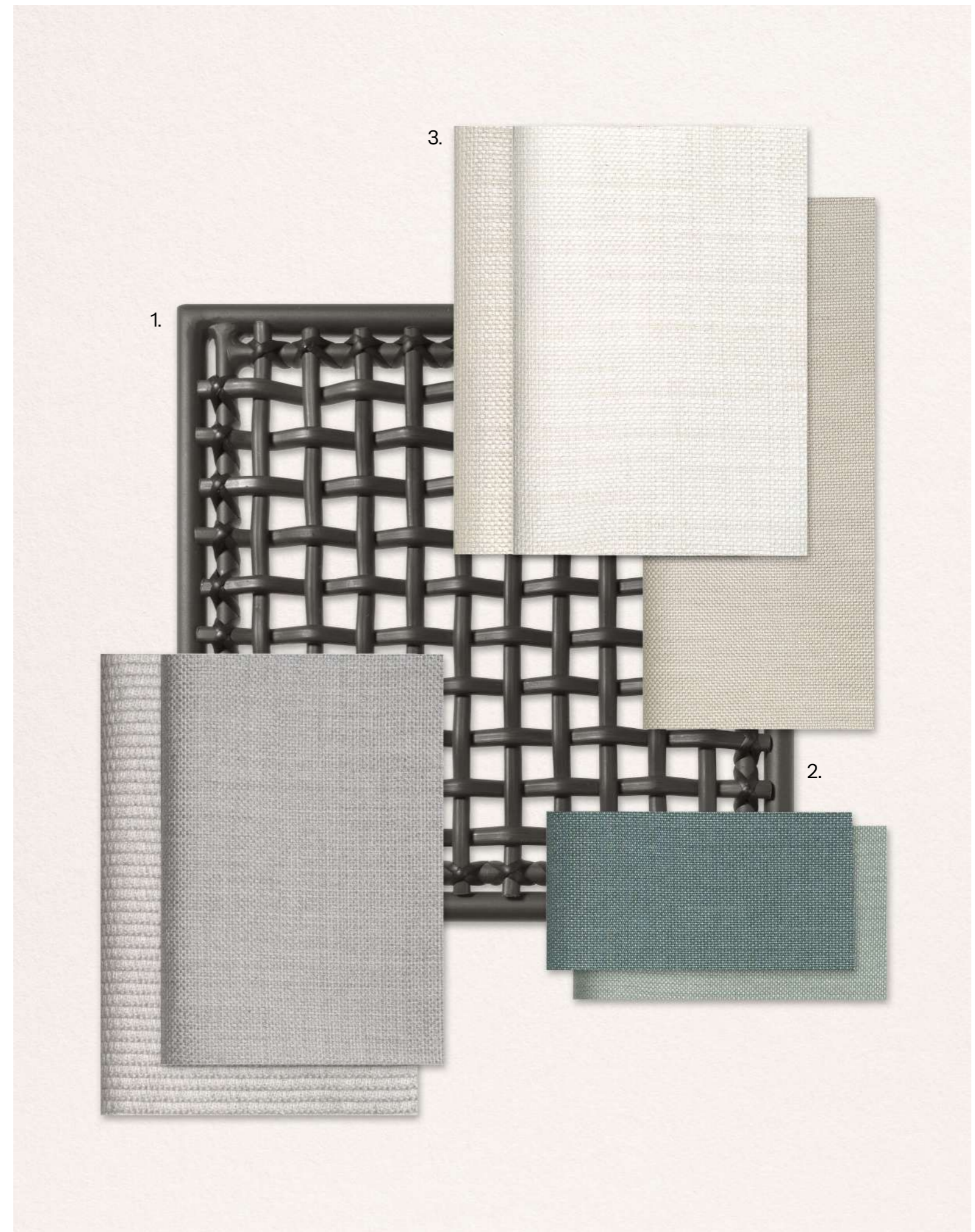

1. Umber grey n-profile 12mm

3. Fabrics

2. Aluminum carbon

Ref: 20121

Sillon Neo Dynasty | *Armchair*

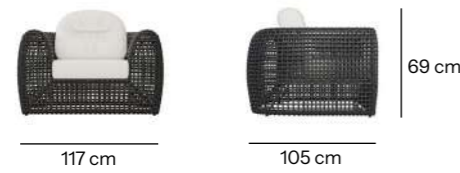

19.79 kg
 0.89 m3
 117x105x69 cm

Alto asiento | *High seat* 43 cm
 Alto brazo | *High arm* 69 cm

Ref: 20122

Sofa 2pl. Neo Dynasty | *Sofa 2St*



33.10 kg
 1.57 m3
 207x105x69 cm

Alto asiento | *High seat* 43 cm
 Alto brazo | *High arm* 69 cm

Ref: 20123

Sofa Neo Dynasty | *Sofa 3St*



37.93 kg
 1.88 m3
 250x105x69 cm

Alto asiento | *High seat* 43 cm
 Alto brazo | *High arm* 69 cm

Ref: 20124

Mesa Centro Neo Dynasty | *Center Table*



19.28 kg
 0.5 m3
 100x100x31 cm

tope cristal o porcelanico | *glass or porcelanic top* 87.7x87.7 cm
 grueso tapa | *thick top* 6 mm

Ref: 20125

Mesa Rincon Neo Dynasty | *Side Table*



8.51 kg
 0.15 m3
 51x51x57 cm

tope cristal o porcelanico | *glass or porcelanic top* 34.5x34.5 cm
 grueso tapa | *thick top* 6 mm

Ref: 20120

Sillon Com. Neo Dynasty | *Dining Armchair*

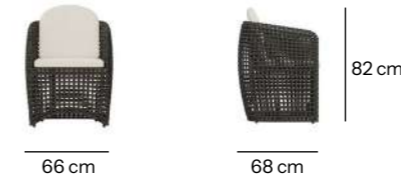

9.19 kg
 0.37 m3
 66x68x82 cm

Alto asiento | *High seat* 47 cm
 Alto brazo | *High arm* 74 cm

Ref: 20164

Mesa Com. Cuadrada Marroi | *Square Dining Table*



31.12 kg
 0.75 m3
 100x100x75 cm

tope teca | *teak top* 100x100 cm
 grueso tapa | *thick top* 4 cm

Ref: 20165

Mesa Com. Rectangular Marroi | *Rect. Dining Table*



36.56 kg
 1,8 m3
 240x100x76 cm

tope teca | *teak top* 240x100 cm
 grueso tapa | *thick top* 4 cm

Ref: 20128

Tumbona Neo Dynasty | *Lounger*



20.66 kg
 0.5 m3
 79x213x30cm

Alto asiento | *High seat* 36 cm

Ref: 20129

Tumbona Doble Neo Dynasty | *Double Lounger*



42.08 kg
 1.18 m3
 170x213x30cm

Alto asiento | *High seat* 36 cm

El volumen especificado se refiere al producto en su estado completamente montado. El peso indicado incluye la estructura del producto junto con los cojines y/o topes correspondientes.

The stated volume refers to the fully assembled product. The indicated weight includes the product structure together with the cushions and/or stoppers.



El volumen especificado se refiere al producto en su estado completamente montado. El peso indicado incluye la estructura del producto junto con los cojines y/o topes correspondientes.

The stated volume refers to the fully assembled product. The indicated weight includes the product structure together with the cushions and/or stoppers.

Ref: 20126

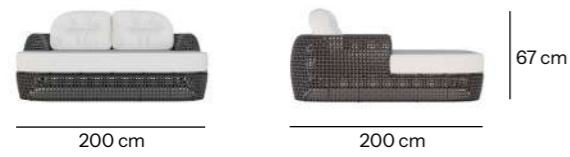
Daybed Bajo Neo Dynasty | *Daybed Low*





 52.48 kg
 1.8 m3
 200x200x67 cm

Alto asiento | *High seat* 48 cm
 Alto brazo | *High arm* 67 cm

Ref: 20127

Mesa Aux. Neo Dynasty | *Aux Table Dynasty*



 6.9 kg
 0.07 m3
 45x51x51 cm

tope cristal | *glass top* 34.5x34.5 cm Ø 38.7 cm
 grueso cristal | *thick glass* 6 mm

El volumen especificado se refiere al producto en su estado completamente montado. El peso indicado incluye la estructura del producto junto con los cojines y/o topes correspondientes.

The stated volume refers to the fully assembled product. The indicated weight includes the product structure together with the cushions and/or stoppers.

Boston collection *by Santiago Sevillano*

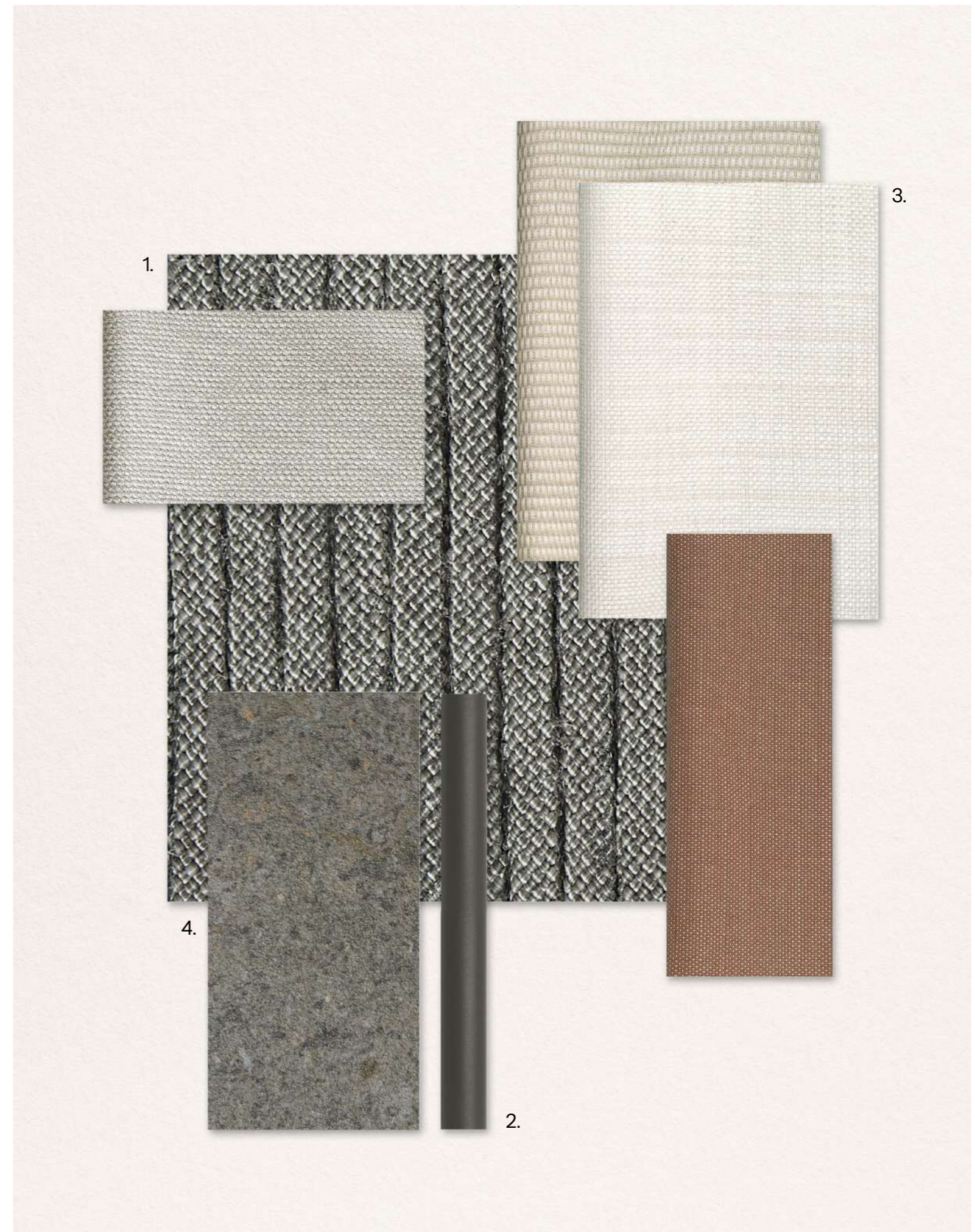

1. Strap light grey frp 16x5 mm



2. Aluminum carbon

3. Fabrics

4. Ceramic tops

Ref: 24151 **Sillon Boston | Armchair**



 12.5 kg
 0.43 m3
 96x83x65 cm

Alto asiento | *High seat* 37 cm
 Alto brazo | *High arm* 65 cm

Ref: 24152 **Sofa 2pl. Boston | Sofa 2St**



 18.65 kg
 0.89 m3
 160x83x65 cm

Alto asiento | *High seat* 37 cm
 Alto brazo | *High arm* 65 cm

Ref: 24153 **Sofa 3pl. Boston | Sofa 3St.**





 25.05 kg
 1.19 m3
 222x83x65 cm

Alto asiento | *High seat* 37 cm
 Alto brazo | *High arm* 65 cm

Ref: 24154 **Mesa Centro Boston | Center Table**





 30.19 kg
 0.27 m3
 120x120x22 cm

tope porcelánico | *porcelanic top* 120x120 cm
 grueso tapa | *thick top* 12 mm

Ref: 24155 **Mesa Rincón Boston | Side Table**



 6.45 kg
 0.06 m3
 50x50x50 cm



tope porcelánico | *porcelanic top* 50x50 cm
 grueso tapa | *thick top* 12 mm

El volumen especificado se refiere al producto en su estado completamente montado. El peso indicado incluye la estructura del producto junto con los cojines y/o topes correspondientes.

The stated volume refers to the fully assembled product. The indicated weight includes the product structure together with the cushions and/or stoppers.

Ref: 24157 **Sillon Com. Boston | Dining Armchair**





 8.7 kg
 0.31 m3
 70x57x65 cm

Alto asiento | *High seat* 49 cm
 Alto brazo | *High arm* 65 cm

Ref: 24159 **Mesa Com. Cuadrada Boston | Square Dining Table**



 20.32 kg
 0.36 m3
 100x100x75 cm

tope porcelánico | *porcelanic top* 100x100 cm
 grueso tapa | *thick top* 12 cm

Ref: 24159.01 **Mesa Com. Rectangular Boston | Rect. Dining Table**





 54.65 kg
 1.07 m3
 220x100x75 cm

tope porcelánico | *porcelanic top* 220x100 cm
 grueso tapa | *thick top* 12 mm

Ref: 24161 **Taburete Boston | Bar Stool**





 10.15 kg
 0.45 m3
 70x57x100 cm

Alto asiento | *High seat* 79 cm
 Alto brazo | *High arm* 100 cm

Ref: 24162.01 **Mesa Bar Boston | Bar Table**



 33.85 kg
 0.76 m3
 140x80x107 cm



tope porcelánico | *porcelanic top* 140x80x1.2 cm
 grueso tapa | *thick top* 12 mm

El volumen especificado se refiere al producto en su estado completamente montado. El peso indicado incluye la estructura del producto junto con los cojines y/o topes correspondientes.

The stated volume refers to the fully assembled product. The indicated weight includes the product structure together with the cushions and/or stoppers.

Ref: 24163 **Tumbona Boston | Lounger**





 23.7 kg
 0.71 m3
 90x220x26 cm

Alto asiento | *High seat* 33 cm

Ref: 24164 **Tumbona Doble Boston | Double Lounger**





 35.55 kg
 1.25 m3
 180x220x26 cm

Alto asiento | *High seat* 33 cm

Ref: 24153 **Sofa 3pl. Boston | Sofa**



 23.45 kg
 1.14 m3
 160x160x66 cm

Alto asiento | *High seat* 35 cm
Alto brazo | *High arm* 66 cm

Ref: 24170 **Macetero S Boston | Planter S**



 7.7 kg
 0.19 m3
 Ø60x50 cm

ancho interior | inside width Ø60 cm
fondo interior | inside depth 40 cm

Ref: 24170.01 **Macetero M Boston | Planter M**



 8.65 kg
 0.23 m3
 Ø60x60 cm

ancho interior | inside width Ø60 cm
fondo interior | inside depth 40 cm

Ref: 24170.02 **Macetero L Boston | Planter L**



 9 kg
 0.26 m3
 Ø60x70 cm

ancho interior | inside width Ø60 cm
fondo interior | inside depth 40 cm

El volumen especificado se refiere al producto en su estado completamente montado. El peso indicado incluye la estructura del producto junto con los cojines y/o topes correspondientes.

The stated volume refers to the fully assembled product. The indicated weight includes the product structure together with the cushions and/or stoppers.

El volumen especificado se refiere al producto en su estado completamente montado. El peso indicado incluye la estructura del producto junto con los cojines y/o topes correspondientes.

The stated volume refers to the fully assembled product. The indicated weight includes the product structure together with the cushions and/or stoppers.

Rodona collection *by Santiago Sevillano*

1. Beige polyrope 8mm

2. Aluminum carbon

3. Fabrics

4. Ceramic tops



Ref: 24171 **Sillon Rodona | Armchair**



10.25 kg
0.49 m³
85x83x71 cm

Alto asiento | *High seat* 42 cm

Ref: 24172 **Sofa 2pl. Rodona | Sofa 2St.**



16 kg
0.64 m³
150x83x71 cm

Alto asiento | *High seat* 42 cm

Ref: 24173 **Sofa 3pl. Rodona | Sofa 3St.**



23 kg
0.91 m³
215x83x71 cm

Alto asiento | *High seat* 42 cm

Ref: 24174 **Mesa Centro Baja Rodona | Low Round Center Table**

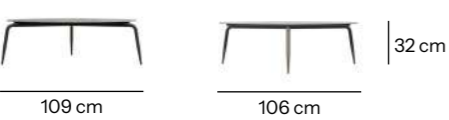

25.05 kg
0.22 m³
109x106x32 cm

tope porcelánico | *porcelanic top* Ø100 cm
grueso tapa | *thick top* 12 mm

Ref: 24175 **Mesa Centro Alta Rodona | High Round Center Table**



25.95 kg
0.22 m³
112x107x45 cm

tope porcelánico | *porcelanic top* Ø100 cm
grueso tapa | *thick top* 12 mm

El volumen especificado se refiere al producto en su estado completamente montado. El peso indicado incluye la estructura del producto junto con los cojines y/o topes correspondientes.

The stated volume refers to the fully assembled product. The indicated weight includes the product structure together with the cushions and/or stoppers.

Ref: 24177 **Sillon Com. Rodona | Dining Armchair**



7.10 kg
0.11 m³
68x61x82 cm

Alto asiento | *High seat* 47 cm

Ref: 24178.01 **Mesa Com. Rodona | Dining Table**



59.3 kg
0.83 m³
200x100x75 cm

tope porcelánico | *porcelanic top* 200x100 cm
grueso tapa | *thick top* 12 mm

Ref: 24179 **Taburete Rodona | Bar Stool**



8.7 kg
0.21 m³
68x61x112 cm

Alto asiento | *High seat* 77 cm

Ref: 24180.02 **Mesa Bar Cuad. Rodona | SQ Bar Table**



27.05 kg
0.34 m³
90x90x105 cm

tope porcelánico | *porcelanic top* 90x90 cm
grueso tapa | *thick top* 12 mm

Ref: 24180.03 **Mesa Bar Rect. Rodona | Rect. Bar Table**

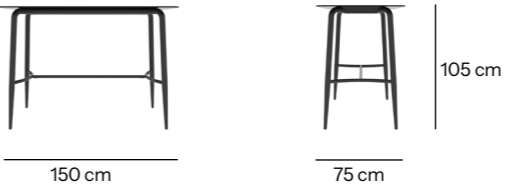

35 kg
0.35 m³
150x75x105 cm

tope porcelánico | *porcelanic top* 150x75 cm
grueso tapa | *thick top* 12 mm

El volumen especificado se refiere al producto en su estado completamente montado. El peso indicado incluye la estructura del producto junto con los cojines y/o topes correspondientes.

The stated volume refers to the fully assembled product. The indicated weight includes the product structure together with the cushions and/or stoppers.

Ref: 24188

Sillon Balcony Rodona | *Balcony Armchair*



8.05 kg
 0.14 m3
 78x71x72 cm

Alto asiento | *High seat* 46 cm

Ref: 24189

Sillon Aux. Alto Rodona | *Aux. High Armchair*



15.5 kg
 0.91 m3
 104x83x128 cm

Alto asiento | *High seat* 53 cm
 alto respaldo | *high backrest* 128 cm

Ref: 24181

Tumbona Rodona | *Lounger*



17.65 kg
 0.3 m3
 95x207x38 cm

Alto asiento | *High seat* 44 cm

Ref: 24184

Daybed Redondo Rodona | *Round Daybed*



30.75 kg
 4 m3
 227x218x81 cm

Alto asiento | *High seat* 40 cm

Ref: 24185

Daybed Bajo Rodona | *Low Daybed*



34.8 kg
 2.07 m3
 165x132,5x67cm

Alto asiento | *High seat* 43 cm

El volumen especificado se refiere al producto en su estado completamente montado. El peso indicado incluye la estructura del producto junto con los cojines y/o topes correspondientes.

The stated volume refers to the fully assembled product. The indicated weight includes the product structure together with the cushions and/or stoppers.

Ref: 24183.01

Mesa Aux. Rodona | *Aux. Table*



6.30 kg
 0.08 m3
 Ø45x40 cm

tope porcelánico | *porcelanic top* Ø45 cm
 grueso tapa | *thick top* 8 mm

El volumen especificado se refiere al producto en su estado completamente montado. El peso indicado incluye la estructura del producto junto con los cojines y/o topes correspondientes.

The stated volume refers to the fully assembled product. The indicated weight includes the product structure together with the cushions and/or stoppers.

Daybeds *Oram collection Neo Cube collection Faber collection Shade collection*

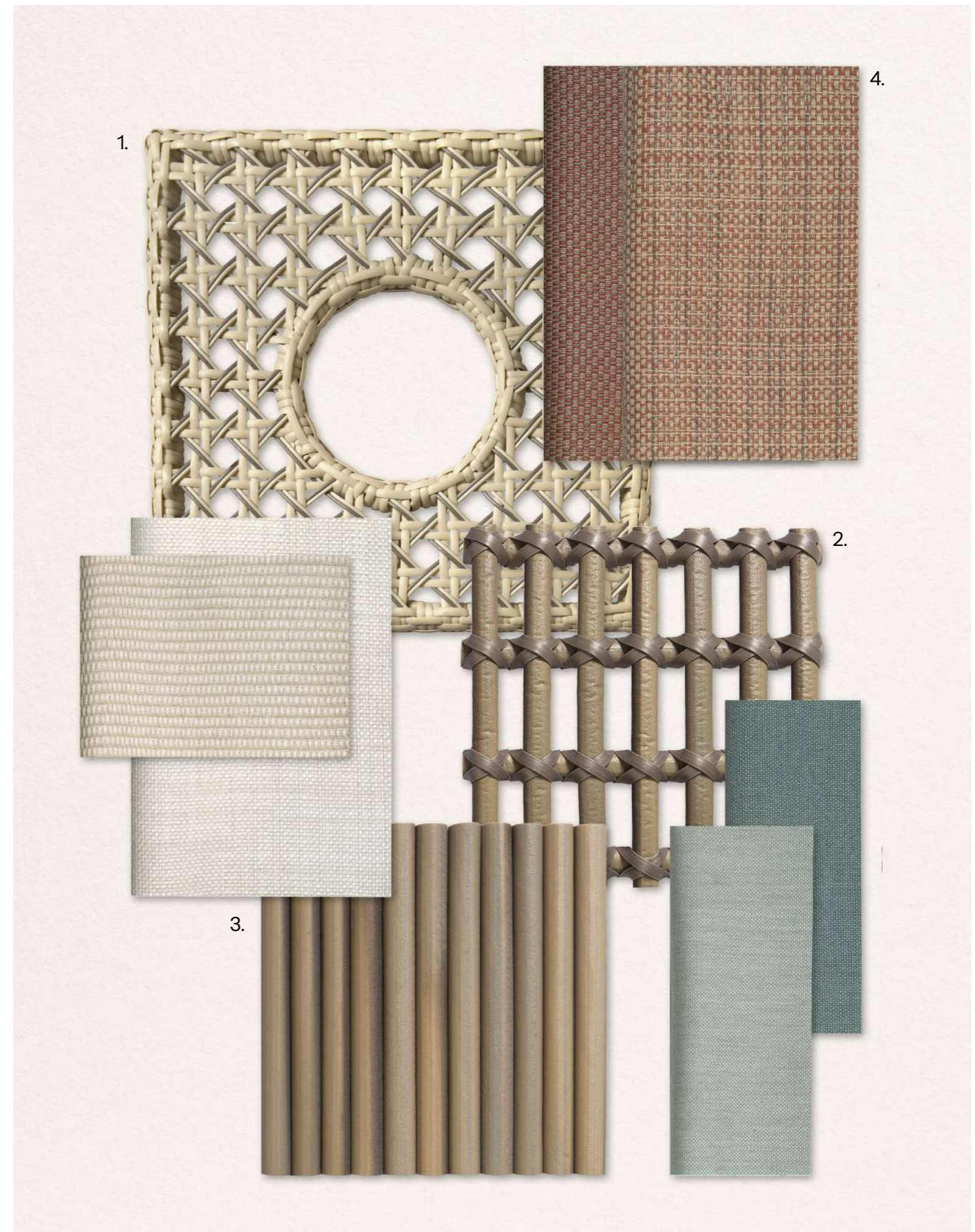

1. Polyrod 3mm + pp7mm white wash (combine)

2. Kubu mushroom np-15mm

3. Kubu betta

4. Fabrics

Ref: 24385

Daybed Oram | *Daybed*

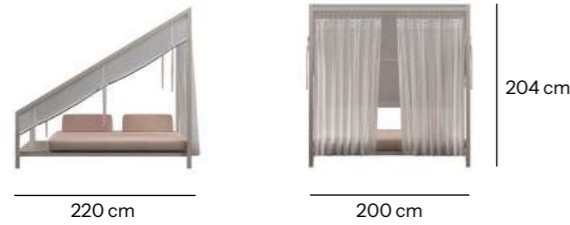

110 kg
 8.97 m3
 220x200x204 cm
 Alto asiento | *High seat* 40 cm
 medida porcelanico / porcelanic size 195x43.5
 grosor porcelanico | porcelanic thick 8 mm

Ref: 23504.01

Daybed Faber | *Daybed*

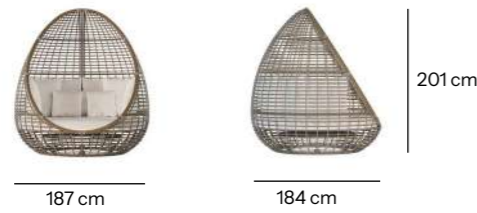

70.15 kg
 2.11 m3
 187X184X201 cm
 Alto asiento | *High seat* 49 cm

Ref: 23504

Daybed Faber Betta | *Daybed*

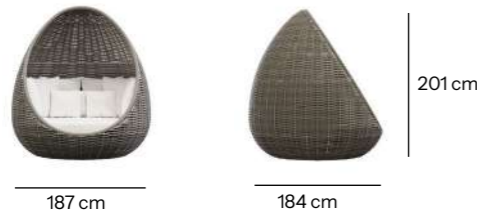

73.25 kg
 6.92 m3
 184X184X201 cm
 Alto asiento | *High seat* 49 cm

Ref: 02973.01

Daybed Shade | *Daybed*

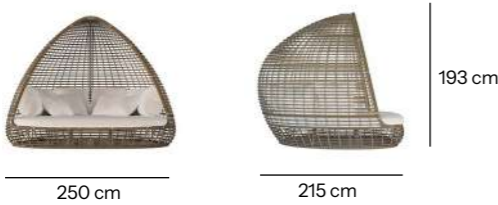

88.4 kg
 4.26 m3
 250X215X193 cm
 Alto asiento | *High seat* 47 cm

Ref: 02973.02.02

Daybed Shade Betta | *Daybed*

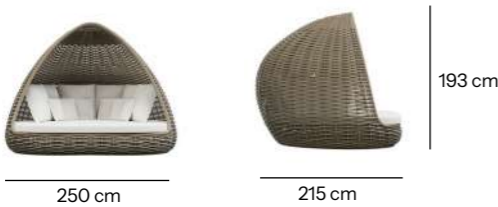

105.03 kg
 8.3 m3
 250X215X193 cm
 Alto asiento | *High seat* 47 cm

Ref: 20163

Daybed Neo Cube | *Daybed*

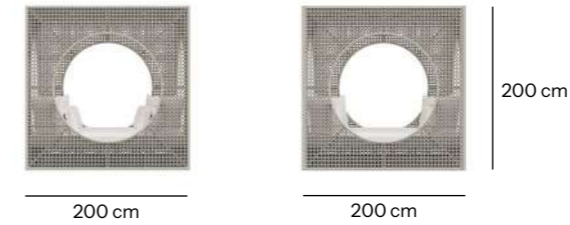

83.82 kg
 2.3 m3
 200x200x200cm
 Alto asiento | *High seat* 42 cm

El volumen especificado se refiere al producto en su estado completamente montado. El peso indicado incluye la estructura del producto junto con los cojines y/o topes correspondientes.

The stated volume refers to the fully assembled product. The indicated weight includes the product structure together with the cushions and/or stoppers.

El volumen especificado se refiere al producto en su estado completamente montado. El peso indicado incluye la estructura del producto junto con los cojines y/o topes correspondientes.

The stated volume refers to the fully assembled product. The indicated weight includes the product structure together with the cushions and/or stoppers.

Product Direction / FatIron Studio

Concept, Art Direction and Visuals
Imenso Studio

Writing Text / Skyline Design

Logo Concept / Jiménez De Nalda ®

VOOLCAN
Grupo

